

NUEVO series

IP66

WEATHER-PROOF FLUORESCENT FITTINGS

- * Polycarbonate Body & Diffuser
- * Stainless Grips

WEATHERPROOF
LIGHTING

NEW

NUEVO series

၂၀၁၆ ခု

**WEATHER
PROOF
FLUORESCENT FITTINGS**

Downlights

- Body Galvanised cool steel 0.5 mm.
- Bezel White stove enamel finish
- Reflector Spun aluminium with matt anodised finish
- Lamp Holder E27 for incandescent & PLC for compact fluorescent lamp

E27 Lamp Holder

ขั้วหลอด E27



M3-E27



E2714

Cat. No.	Description	Pack
M3-E27	ขั้วหลอด E27 สำหรับการติดตั้งแบบลอย E27 Lamp Holder for Surface Mounting	10/100
E2714	ขั้วหลอด E27 สำหรับแปลงเป็นขั้วหลอด E14 E27 Lamp Holder Adaptor to E14	40



DOWNLIGHT

Vertical Recessed Downlights

E27 Lamp Holder



Cat. No.	Dia. (Inch)	Outside Dia. (mm.)	Cutting Dia. (mm.)	Height (mm.)	Packing
HV-TD3.5	3 ^{1/2} "	φ124	φ95	140	1/40
HV-TD4	4"	φ143	φ120	175	1/40
HV-TD5	5"	φ180	φ152	206	1/24
HV-TD6	6"	φ190	φ170	212	1/24
HV-TD8	8"	φ228	φ204	240	1/12

Horizontal Recessed Downlights (with Gear Boxes)

PLC Lamp Holder



Cat. No.	Dia. (Inch)	Outside Dia. (mm.)	Cutting Dia. (mm.)	Height (mm.)	PLC Lamp Holder	Packing
HH-TD5/1	5"	φ180	φ152	110	1 Unit	1/20
HH-TD5/2	5"	φ180	φ152	110	2 Unit	1/20
HH-TD6/2	6"	φ190	φ172	120	2 Unit	1/20
HH-TD8/2	8"	φ228	φ204	125	2 Unit	1/12

Bulkhead Luminaires **IP44** Class II

Oyster Style

Oyster
Style

Bulkhead Luminaires **IP55** Class II

Oval Style

Oval Style

**Polycarbonate Material (PC)*

BULKHEAD
LUMINAIRES
WEATHER-PROOF

Bulkhead Luminaires IP44 Class II
โคมไฟส่องสว่าง (โคมไฟกันน้ำแบบซาลาเปากม)



โคมป้องกันฝุ่นและแมลง

IP44



CL-0607/E, CL-0607/P
 Dimension : Ø 180 mm. (7")
 Height : 100 mm. (4")



CL-1009/E, CL-1009/P
 Dimension : Ø 230 mm. (9")
 Height : 110 mm. (4 1/4")

Cat. No.	Description	Pack
CL-0607/E	พร้อมขั้ว E27 (VDE mark) 60 วัตต์ For E27 Bulb Lamp (60W) Ø7"	1/20
CL-0607/P	พร้อมขั้ว PL และบัลลาสต์ (1 x 7 วัตต์) For PL with Lamp Holder and Ballast (1 x 7 W) Ø7"	1/20
CL-1009/E	พร้อมขั้ว E27 (VDE mark) 100 วัตต์ For E27 Bulb Lamp (100W) Ø9"	1/20
CL-1009/P	พร้อมขั้ว PL และบัลลาสต์ (2 x 9 วัตต์) For PL with Lamp Holder and Ballast (2 x 9 W) Ø9"	1/20

Bulkhead Luminaires IP55 Class II
โคมไฟส่องสว่าง (โคมไฟรูปไข่)



โคมป้องกันฝุ่นและแมลง

IP55



WL-0607/TE, WL-0607/TP

WL-0607/YE, WL-0607/YP



WL-0607/RE, WL-0607/RP

WL-0607/GE, WL-0607/GP



Dimension : W 130 mm. (5")
 L 225 mm. (9")
 H 100 mm. (4")
 Diffuser Color : Transparent (T) สีใส
 Yellow (Y) สีเหลือง
 Red (R) สีแดง
 Green (G) สีเขียว

Cat. No.	Description	Pack
WL-0607/TE	พร้อมขั้ว E27 (VDE mark) 60 วัตต์ สีใส For E27 Bulb Lamp (60W) Transparent	1/20
WL-0607/YE	พร้อมขั้ว E27 (VDE mark) 60 วัตต์ สีเหลือง For E27 Bulb Lamp (60W) Yellow	1/20
WL-0607/RE	พร้อมขั้ว E27 (VDE mark) 60 วัตต์ สีแดง For E27 Bulb Lamp (60W) Red	1/20
WL-0607/GE	พร้อมขั้ว E27 (VDE mark) 60 วัตต์ สีเขียว For E27 Bulb Lamp (60W) Green	1/20
WL-0607/TP	พร้อมขั้ว PL และบัลลาสต์ (1x7 วัตต์) สีใส For PL with Lamp Holder + Ballast (1x7 W) Transparent	1/20
WL-0607/YP	พร้อมขั้ว PL และบัลลาสต์ (1x7 วัตต์) สีเหลือง For PL with Lamp Holder + Ballast (1x7 W) Yellow	1/20
WL-0607/RP	พร้อมขั้ว PL และบัลลาสต์ (1x7 วัตต์) สีแดง For PL with Lamp Holder + Ballast (1x7 W) Red	1/20
WL-0607/GP	พร้อมขั้ว PL และบัลลาสต์ (1x7 วัตต์) สีเขียว For PL with Lamp Holder + Ballast (1x7 W) Green	1/20

NUEVO series

IP66

WEATHER-PROOF FLUORESCENT FITTINGS

WEATHERPROOF
LIGHTING

- * Polycarbonate Body & Diffuser
- * Stainless Grips

NEW

NUEVO series

ရန်ကင်း

**WEATHER
PROOF
FLUORESCENT FITTINGS**

Description :

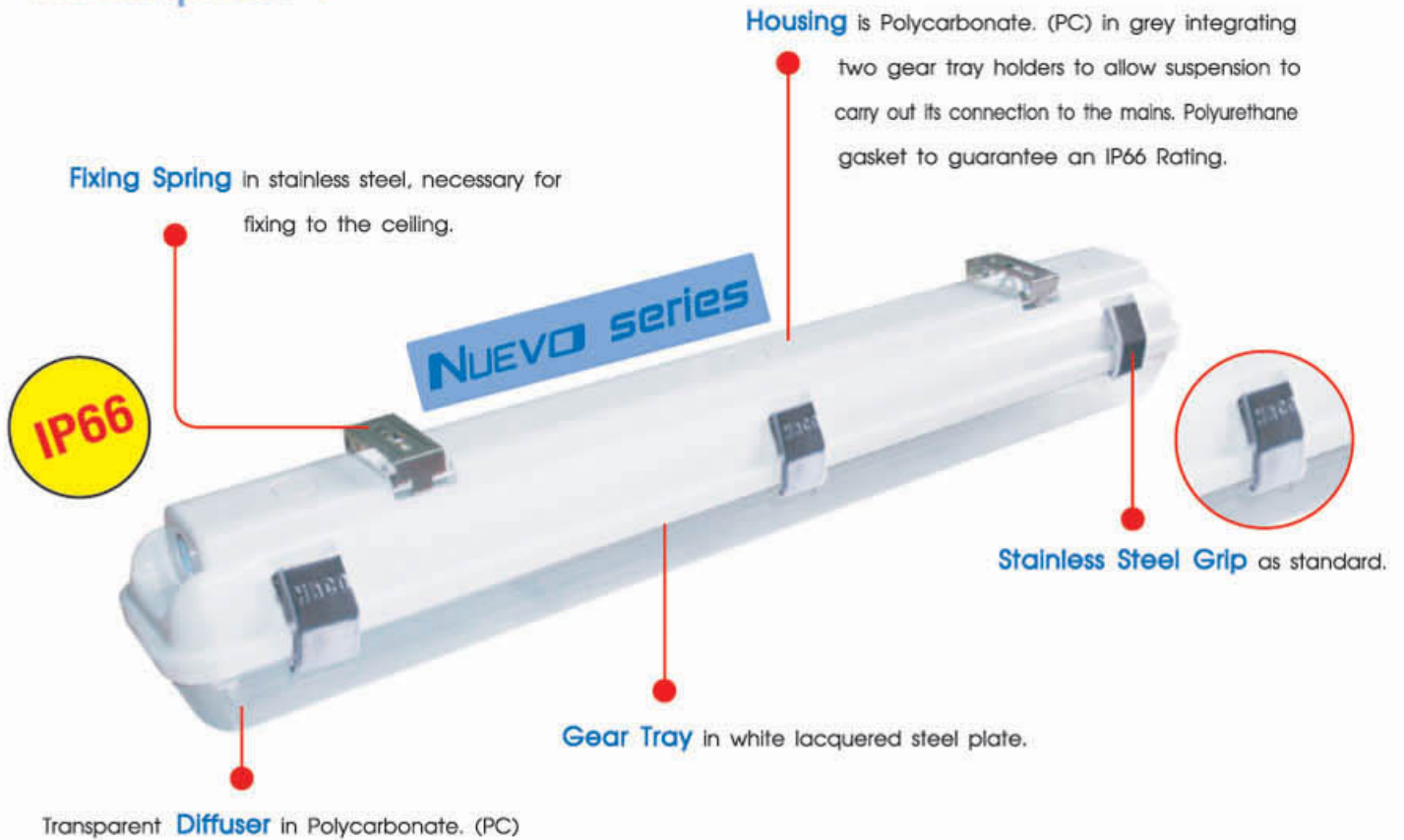

Dimension :

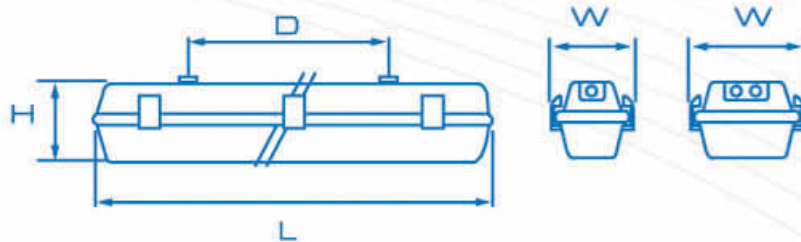

Cat. No.	Lamps (watts)	L (mm.)	W (mm.)	H (mm.)	D (mm.) (Drilling template)
WPL-0118	1x18	660	100	95	400
WPL-0218	2x18	660	145	95	400
WPL-0136	1x36	1,267	100	95	900
WPL-0236	2x36	1,267	145	95	900
WPL-0158	1x58	1,567	100	95	900
WPL-0258	2x58	1,567	145	95	900

IP66 WEATHER-PROOF FLUORESCENT FITTINGS

Specification Polycarbonate Body & Diffuser + Stainless
Grips + VDE Lamp Holder + VD Starter Holder + VDE Terminal board
+ VDE Wire + VDE Cable Glands + Fitting accessories.

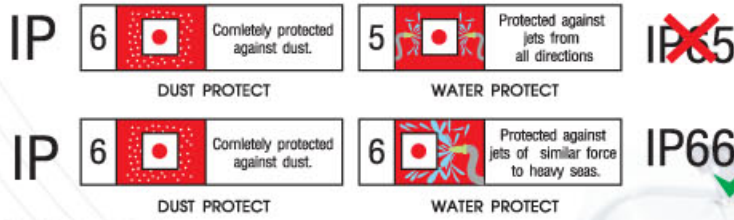

ยึดด้วย Stainless Clips
จำนวนมากกว่าแข็งแรง
ไม่เป็นสนิม

NUEVO series

โคมไฟกันน้ำ **IP66**
ทนต่อทุกสภาพอากาศ

WEATHER PROOF FLUORESCENT FITTINGS

Weather-Proof Fluorescent Fittings

โคมไฟกันน้ำ (รุ่นบูโง)



Cat. No.	Amount of Stainless Grip Per Set		Description	Size (mm.) L x W x H
	HACO	Other		
WPL-0118	6 pcs	4 pcs	1 x 18 watt	660 x 100 x 95
WPL-0218	6 pcs	6 pcs	2 x 18 watt	660 x 145 x 95
WPL-0136	10 pcs	8 pcs	1 x 36 watt	1,267 x 100 x 95
WPL-0236	10 pcs	8 pcs	2 x 36 watt	1,267 x 145 x 95
WPL-0158	12 pcs	10 pcs	1 x 58 watt	1,567 x 100 x 95
WPL-0258	12 pcs	10 pcs	2 x 58 watt	1,567 x 145 x 95

Stainless Grip

คลิปล็อกสแตนเลส



Cat. No.	Description	Amount of Stainless Grip Per Set
SG03	คลิปล็อกสแตนเลส Stainless Grip	1 x 18w - 6 pcs 2 x 18w - 6 pcs 1 x 36w - 10 pcs 2 x 36w - 10 pcs 1 x 58w - 12 pcs 2 x 58w - 12 pcs

Remarks: Prices do not include ballast, capacitor, starter, fluorescent tube. (available upon request)

หมายเหตุ: ราคาไม่รวมอุปกรณ์สตาร์ทเตอร์ บัลลาสต์ คาปาซิเตอร์ (HPF) ฟิวส์ และเทอร์มินอล

CONCRETE POLE & WALL BRACKET

For **IP66** Fluorescent Light Fittings

NEW

CONCRETE POLE



BK1218

BK1236

* Complete with Weatherproof Junction Box, Fuse, Terminal & Internal Wiring.



Cat. No.	Description
BK1218	Bracket for 1x18 & 2x18 watts Fittings
BK1236	Bracket for 1x36 & 2x36 watts Fittings

Dimension (cm.)

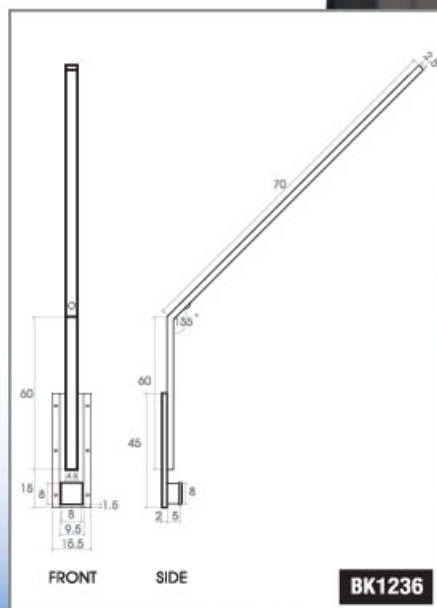
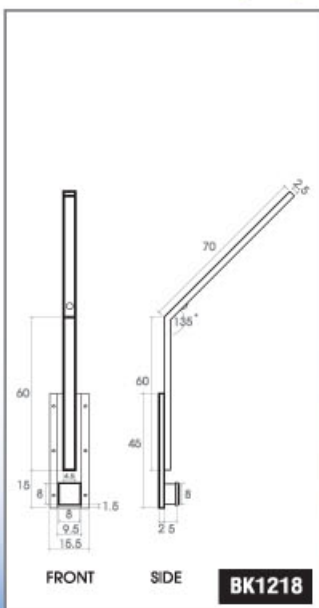

Suitable for

NUEVO series

Weatherproof Lighting

Specification

- IP67 Rated fluorescent fitting for reliable operation in ambient temperature -40°C to $+25^{\circ}\text{C}$
- Supplied with electronic pulsestarter, ballast with condenser (HPF), fuse & terminal block.

For Cool Room -40°C



Accessories / Options

(upon request)

- Bright anodised aluminium mirror reflector.
- Stainless steel suspension bracket.
- Emergency-Light Version.

Description

CRL Series (Low Temperature -40°C)

A special range of precise molded weatherproof luminaires designed for use in specific adverse cold environments. They are dustproof, rustproof, weatherproof and corrosion-resistant. CRL is available in single and twin tube versions with UV stabilised polycarbonate diffuser and inner polycarbonate sleeve to ensure high tube light output at low temperature -40°C .

Features

- U.V. stabilised polycarbonate diffuser.
- Fiber-Glass reinforced polyester body.
- High IP67 rating achieved by machine poured polycarbonate foam gasket between the cover and body.
- Lampholders feature additional polycarbonate inner sleeve to insulate lamps.
- Electronic pulsestarter on both models ensure long tube life helping to reduce costly maintenance.
- Stainless grip for holding the diffuser.
- 20mm. cable gland IP67 entry at both ends.
- Internal wiring terminated at 6mm. 2ways terminal block with fuse unit.
- Manufactured in accordance with IEC 598/AS 3137.

COOL ROOM

Cool Room Luminaires

โคมไฟห้องเย็น



Cat. No.	Lamps	Dimension (mm.)		
		L	W	H
CRL 118 LC	1 x 18W	705	120	115
CRL 218 LC	2 x 18W	705	190	115
CRL 136 LC	1 x 36W	1315	120	115
CRL 236 LC	2 x 36W	1315	190	115
CRL 158 LC	1 x 58W	1615	120	115
CRL 258 LC	2 x 58W	1615	190	115

Remarks: Price includes all control gears. (except fluorescent tube)

หมายเหตุ: ราคารวมอุปกรณ์เสริมครบชุด (ยกเว้นหลอดไฟ)



Cool Room

**HALOGEN SECURITY LIGHT CONTROL WITH MOTION DETECTOR
(OR PERMANENTLY ON)**

Liteguard

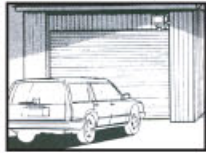

จอภาพในการตรวจจพบการเคลื่อนไหว

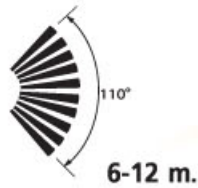

- ตรวจจับความเคลื่อนไหวด้วยความร้อนอินฟราเรด
- สามารถตั้งช่วงเวลาได้
- มีระบบตั้งการทำงานด้วยความเข้มของแสง โดยระบบจะทำงานเมื่อมีค่าความเข้มของแสงน้อยกว่าค่าที่ตั้งไว้
- สามารถเปิดให้ไฟสว่างได้ตลอดเมื่อต้องการ (กดสวิตช์ 2 ครั้ง)
- สามารถต่อพ่วงกับกระดิ่งเตือนภัย
- เหมาะสำหรับติดตั้งทั้งภายในและภายนอก

LITEGUARD

SAVE ENERGY

IP44

Liteguard & PIR Motion Sensor

โคมไฟป้องกันภัยอัตโนมัติ(โดยตรวจจับการเคลื่อนไหว)



RMS-65

สินค้าขายดี



ES34

NEW

Cat. No.	Description	Pack
LITEGUARD		
RMS-65	220V~240V/50Hz 150W White Color Body IP44  Light Bulb Included	1
H-150	Halogen Light Bulb 220V~240V 150W R75	1/10
PIR MOTION SENSOR		
ES34	- 180°/110° PIR Motion Sensor - 1100W High Lighting Load Capacity - Manual override facility	1